



GEANT4
A SIMULATION TOOLKIT



More on Geometry

I. Hrivnacova, IJCLab Orsay

Credits: T. Nikitina, J.Apostolakis, G.Cosmo, A. Lechner (CERN), M. Asai (SLAC) and others

Geant4 IN2P3 and ED PHENIICS Tutorial,
22 – 26 May 2023

Outline

- More on detector description
 - Repeated placements
 - Special techniques of placements
 - Parallel geometries
- Geometry checking tools
- Optimization techniques

Repeated Placements

Physical Volumes

- Physical volume represents a placement of a daughter volume in its mother volume
 - It holds the information about the position of the daughter in the mother reference frame
- Physical volume types:
 - Simple placement: “placement”
 - Repeated placement: “replica”, “division”, “parameterised volume”
- A mother volume can contain either
 - More simple volume placements OR
 - One repeated volume

Replicated Volumes

- The mother volume is sliced into replicas, all of the same size and dimensions.
- Depending on the mother shape, replication may occur along:
 - Cartesian axes (**X**, **Y**, **Z**) – slices are considered perpendicular to the axis of replication
 - Coordinate system at the center of each replica
 - Radial axis (**Rho**) – cons/tubs sections centered on the origin and un-rotated
 - Coordinate system same as the mother
 - Phi axis (**Phi**) – phi sections or wedges, of cons/tubs form
 - Coordinate system rotated such as that the X axis bisects the angle made by each wedge

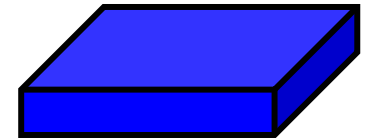

a daughter
logical volume to
be replicated

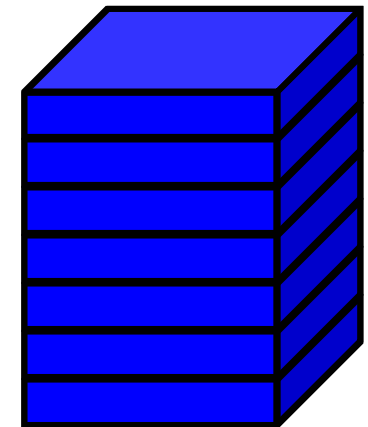

mother volume

G4PVReplica

- G4PVReplica constructor:

```
G4PVReplica(  
    const G4String& name,           // physical volume name  
    G4LogicalVolume* currentLV,    // volume being replicated  
    G4LogicalVolume* motherLV,    // mother logical volume  
    const EAxis axis,              // axis of replication  
    const G4int nofReplicas,       // number of replicas  
    const G4double width,          // replication width  
    const G4double offset = 0);    // offset (optional)
```

- Features and restrictions:
 - Replicas can be placed inside other replicas
 - Normal placement volumes can be placed inside replicas, assuming no intersection/overlaps with the mother volume or with other replicas
 - No volume can be placed inside a radial replication
 - Parameterised volumes cannot be placed inside a replica
 - An offset may be used only for tube/cone segment

Replica – axis, width, offset

- Cartesian axes - $kXAxis$, $kYAxis$, $kZAxis$
 - Offset shall not be used
 - Center of n-th daughter is given as $-width*(nReplicas-1)*0.5+n*width$
- Radial axis - $kRho$
 - Center of n-th daughter is given as $width*(n+0.5)+offset$
- Phi axis - $kPhi$
 - Center of n-th daughter is given as $width*(n+0.5)+offset$

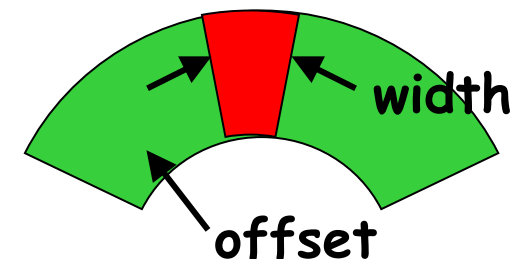
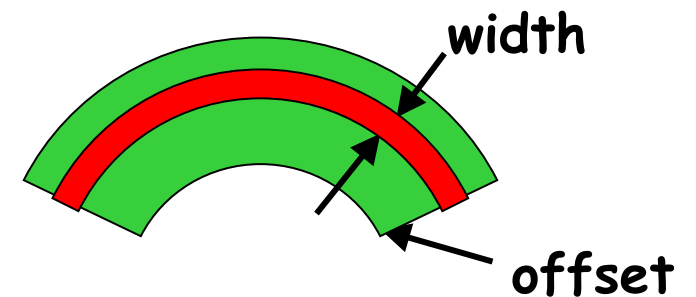
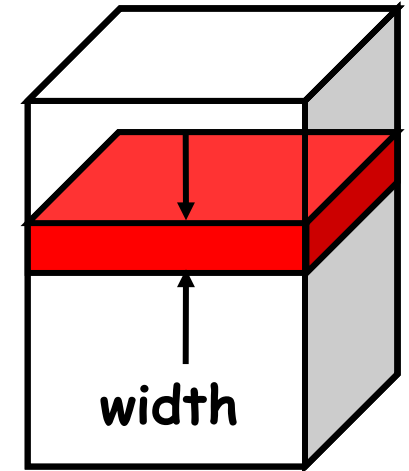

Example

- Tube replicated in phi axis

```
// mother tube volume
G4double dphi = 360.*deg;
G4VSolid* tubeS
    = new G4Tubs("tube", 20*cm, 50*cm, 30*cm, 0., dphi);
G4LogicalVolume* tubeLV
    = new G4LogicalVolume(tubeS, Ar, "tube");
new G4PVPlacement(0, G4ThreeVector(),
                 tubeLV, "tube", worldLV, false, 0);

// division in 6 phi segments
G4double divDphi = dphi/6.;
G4VSolid* divTubeS
    = new G4Tubs("divTube", 20*cm, 50*cm, 30*cm,
               -divDphi/2., divDphi);
G4LogicalVolume* divTubeLV
    = new G4LogicalVolume(divTubeS, Ar, "divTube");
new G4PVReplica("divTube", divTubeLV, tubeLV, kPhi, 6, divDphi);
```

Divisions

- Implemented as “special” kind of parameterised volumes:
 - [G4PVDivision](#) class derived from [G4PVParameterised](#)
 - But simpler to define as the parameterisation is calculated automatically using the values provided in input
- Similar to [G4PVReplica](#)
 - But it allows gaps in between mother and daughter volumes or between daughters (offset)
- Applies to CSG-like and some specific solids only:
 - Box, tubs, cons, para, trd, polycone, polyhedra

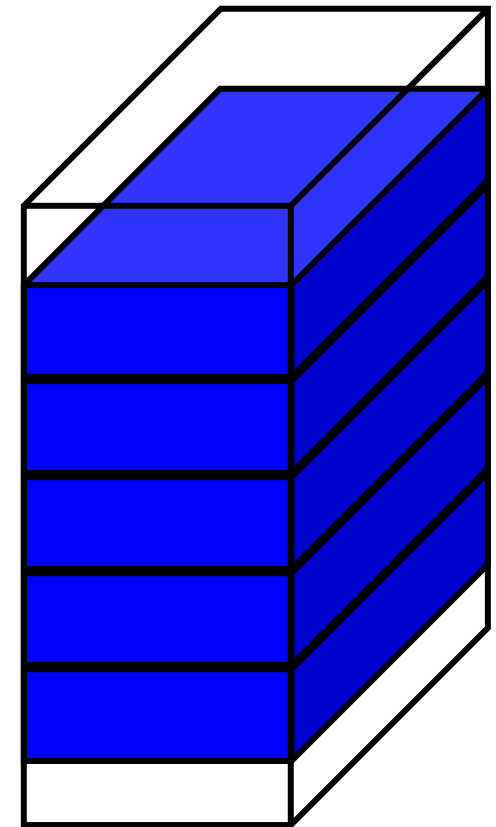

mother volume

Parameterised Volumes

- Defined by [G4PVPParameterised](#)
 - More general than [G4PVReplica](#) and [G4PVDivisions](#)
 - The properties of the “replicas” in their mother volume are defined in a user parameterisation class derived from [G4VPVParameterisation](#)
- The properties which must be always provided:
 - Where it is positioned (transformation, rotation)
- Optional:
 - The size of the solid (dimensions)
 - The type of the solid, material, sensitivity, vis attributes
- The properties of the “replicas” are defined via their [copyNumber](#)

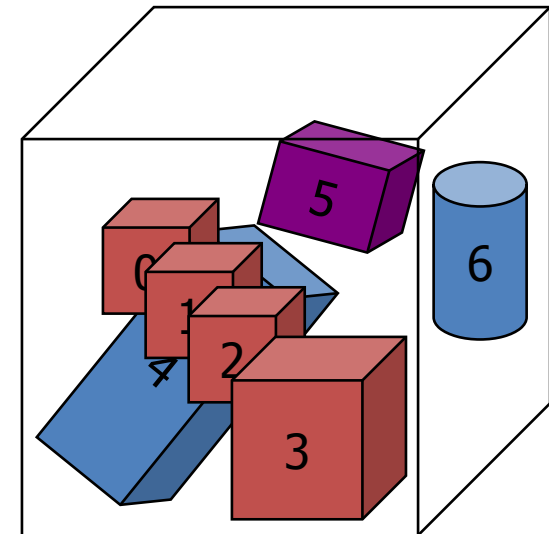

Example

- Basic example B2: the same geometry with simple placements (B2a) and parameterised volume (B2b)

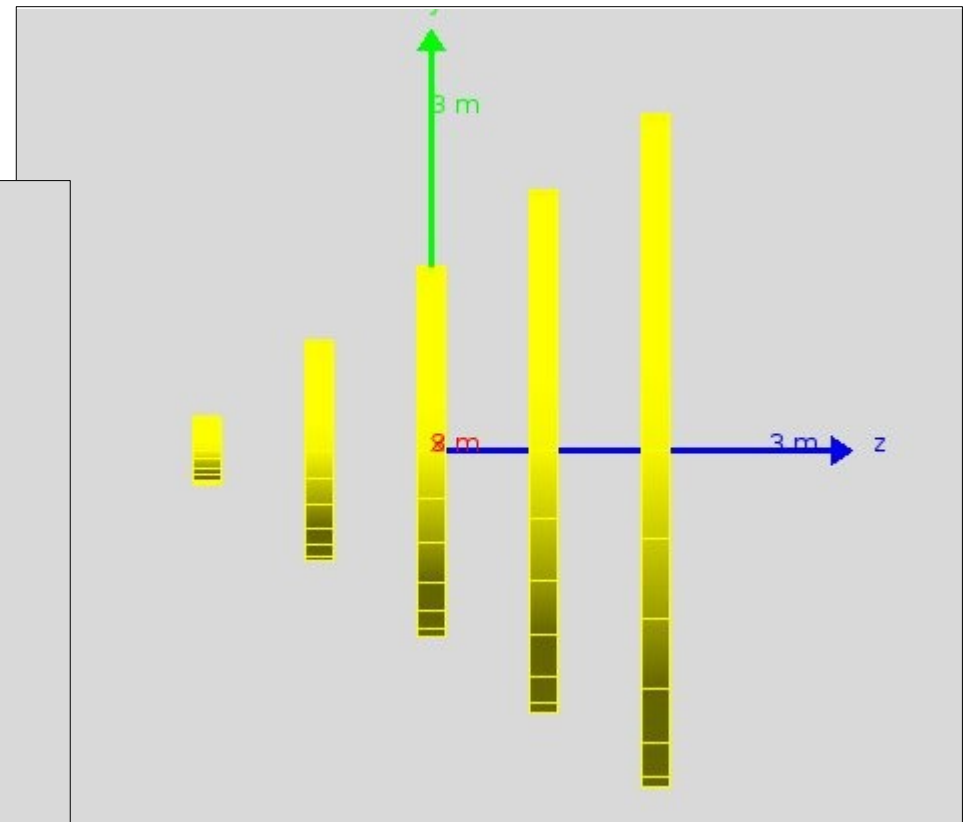
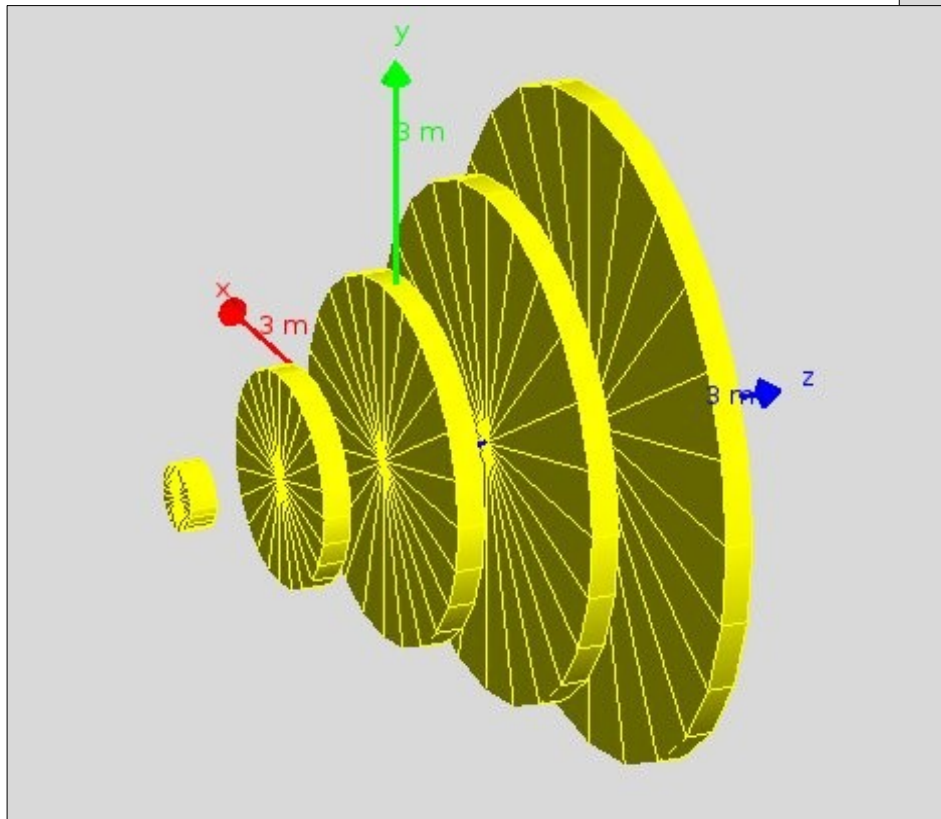

See the implementation details in backup slides

Special Techniques of Placements Assemblies, Reflections

Grouping Volumes

- To represent a regular pattern of positioned volumes, composing a more or less complex structure
 - structures which are hard to describe with simple replicas or parameterised volumes
 - structures which may consist of different shapes
 - too densely positioned to utilize a mother volume
- Assembly volume
 - [G4AssemblyVolume](#) class
 - acts as an envelope for its daughter volumes
 - its role is over once its logical volume has been placed
 - daughter physical volumes become independent copies in the final structure
- Participating daughter logical volumes are treated as triplets
 - logical volume
 - translation w.r.t. envelop
 - rotation w.r.t. envelop

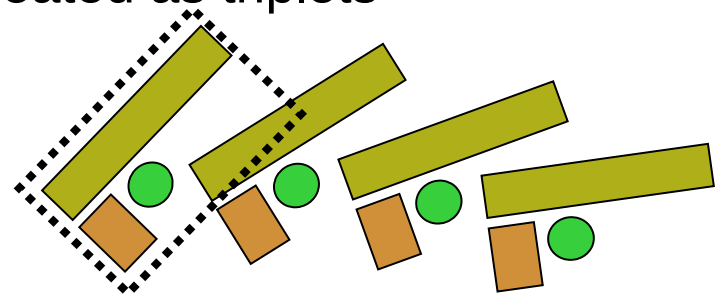

G4AssemblyVolume: Example

```
// Define the green box
G4VSolid* longBoxS = new G4Box("longBox", ...);
G4LogicalVolume* longBoxLV
  = new G4LogicalVolume(longBoxS, Pb, "longBox");
// Define the smallbox -> smallBoxLV
// Define the tube -> tubeLV

// Make assembly
G4AssemblyVolume* myAssembly = new G4AssemblyVolume();
// Define transformations of volume inside the assembly:
// lbPosition, lbRotation, ...
myAssembly->AddPlacedVolume(longBoxLV, lbPosition, lbRotation);
myAssembly->AddPlacedVolume(smallBoxLV, sbPosition, sbRotation);
myAssembly->AddPlacedVolume(tubeLV, tubePosition, tubeRotation);

// Now place the assemblies
for (G4int int i = 0; i < 4; i++ ) {
  // Define the position and rotation of each assembly
  // ithPosition, ithRotation
  myAssembly->MakeImprint(worldLV, ithPosition, ithRotation);
}
```

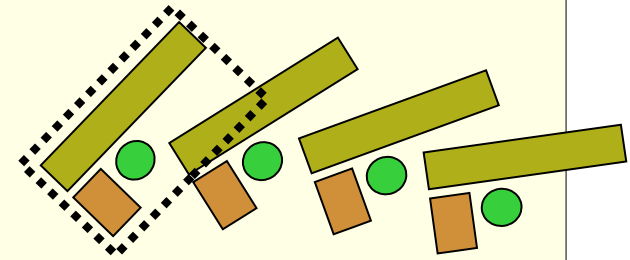

Reflecting volumes

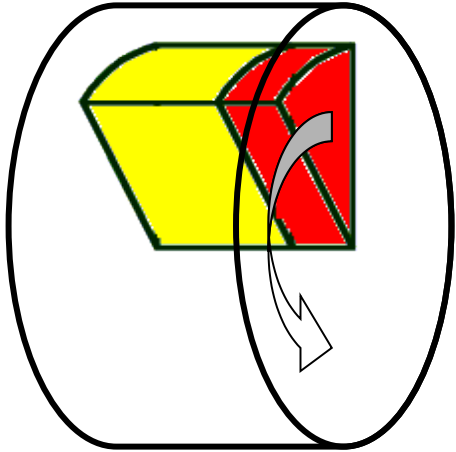

- Let's take an example of a pair of mirror symmetric volumes.
- Such geometry cannot be made by parallel transformation or 180 degree rotation.

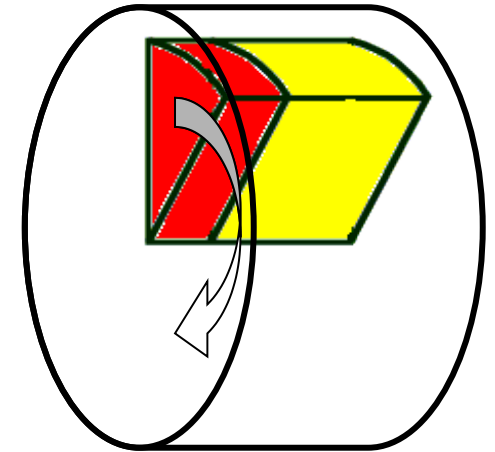

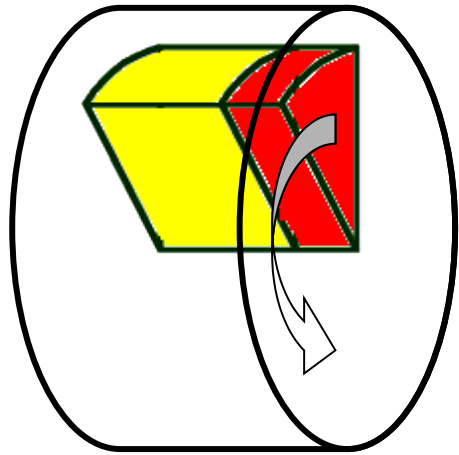

Reflecting volumes

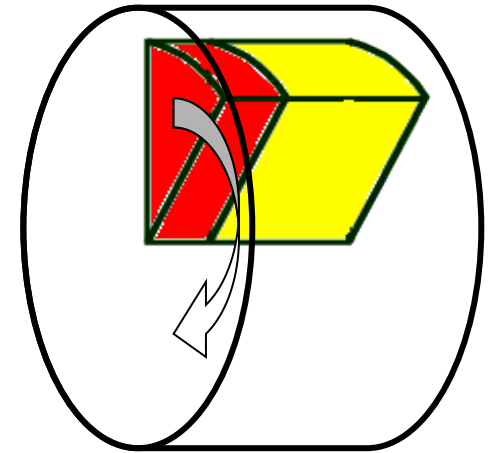

- Hierarchies of volumes based on CSG or specific solids can be reflected by means of [G4ReflectionFactory](#)
 - Singleton object using [G4ReflectedSolid](#) for generating placements of reflected volumes
 - The functions [Place\(..\)](#) or [Replicate\(..\)](#) should be used instead of [G4PVPlacement](#) or [G4PVReplica](#) when placing or replicating a volume in a volume hierarchy containing reflections
 - See more details in backup slides
- [G4ReflectedSolid](#)
 - Utility class representing a solid shifted from its original reference frame to a new symmetric one
 - The reflection ([G4Reflect\[X/Y/Z\]3D](#)) is applied directly to a solid, and a reflected solid is placed with “pure” rotation and translation
 - Reflections can be applied to CSG and specific solids

Parallel Geometries

Parallel Navigation

- Occasionally, it may not be straightforward to define attributes, like sensitivity, importance or envelope to be assigned to volumes in the mass geometry
 - Typically applicable to geometries imported from CAD, GDML, DICOM, etc.
- Parallel navigation functionality allows to define more than one overlapping geometry setups (worlds) simultaneously
 - The [G4Transportation](#) process can act on all worlds simultaneously
 - A step is limited not only by the boundary of the original mass geometry but also by the boundaries of each parallel geometry
 - Materials, production thresholds and EM field are used only from the mass geometry
 - In a parallel world, the user can define volumes in arbitrary manner with sensitivity, regions with shower parameterization, and/or importance field for biasing
 - Volumes in different worlds may overlap

Example RE06

- [extended/runAndEvent/RE06](#)
- Mass geometry
 - Sandwich of rectangular absorbers and scintillators
- Parallel scoring geometry
 - Cylindrical layers

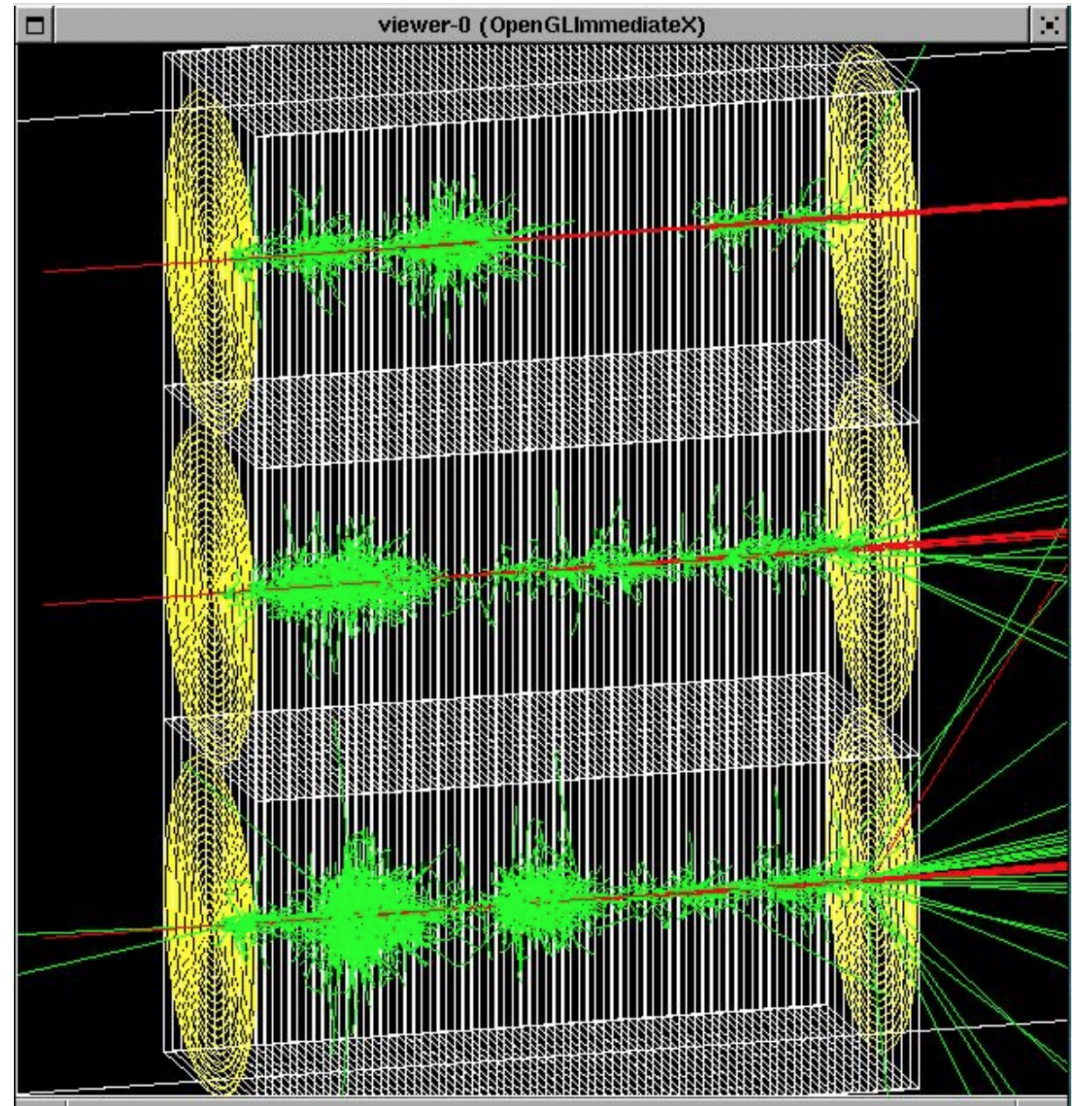

HEP use case

- A parallel world may be associated only to some limited types of particles
- May define geometries of different levels of detail for different particle types
- Example for **sampling calorimeter**: the mass world defines only the crude geometry with averaged material, while a parallel world with all the detailed geometry. Real materials in detailed parallel world geometry are associated with all particle types except e^+ , e^- and gamma
 - e^+ , e^- and gamma do not see volume boundaries defined in the parallel world, i.e. their steps won't be limited
- Shower parameterisations may have their own geometry



Geometry seen by e^+ , e^- , γ

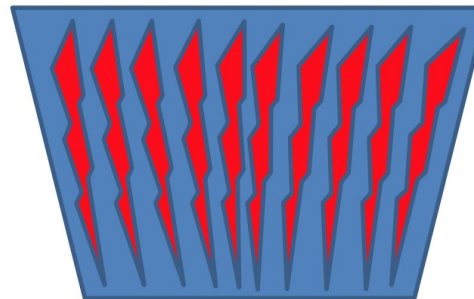

Geometry seen by other particles

Advanced Geant4 Course - Geometry II - G.Cosmo (CERN)

Geometry Checking Tools

Debugging Geometries

- A **protruding volume** is a contained daughter volume which actually protrudes from its mother volume.
- Volumes are also often positioned in a same volume with the intent of not provoking intersections between themselves. When volumes in a common mother actually intersect themselves are defined as **overlapping**.
- **Geant4 does not allow** for malformed geometries, neither **protruding nor overlapping**.
 - The behavior of navigation is unpredictable for such cases.
- The problem of detecting overlaps between volumes is bounded by the complexity of the solid models description.
- Utilities are provided for detecting wrong positioning
 - Optional checks at construction
 - Kernel run-time commands
 - Graphical tools (vis commands)

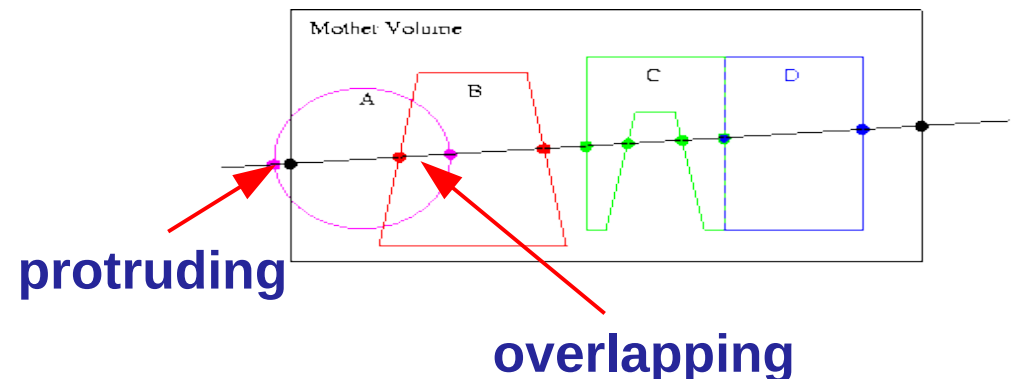

Optional Checks at Construction

- The option to check overlaps at geometry construction can be activated in the G4PVPlacement constructor :

```
G4PVPlacement(  
  G4RotationMatrix* rotation,           // rotation  
  const G4ThreeVector& translation,     // translation  
  G4LogicalVolume* currentLV,          // volume being placed  
  const G4String& name,                 // physical volume name  
  G4LogicalVolume* motherLV,           // mother logical volume  
  G4bool many,                          // not used  
  G4int copyNumber,                    // position (copy) number  
  G4bool surfaceCheck = false);        // option to activate  
                                        // overlap checking
```

- Some number of points are then randomly sampled on the surface of creating volume.
- Each of these points are examined
 - If it is outside of the mother volume, or
 - If it is inside of already existing other volumes in the same mother volume.
- This check requires lots of CPU time, but it is worth to try at least once when you implement your geometry of some complexity.

Optional Checks at Construction - 2

- Alternatively, one can use explicitly the overlaps check for a simple physical volume:

```
G4bool CheckOverlaps(G4int res=1000, G4double tol=0.,  
                    G4bool verbose=true, G4int errMax=1)
```

- Verifies if the placed volume is overlapping with existing daughters or with the mother volume.
- Returns true if the volume is overlapping.

Debugging Run-time Commands

- Verification of geometry for overlapping regions recursively through the volumes tree can be a run with a built-in run-time command:
 - `geometry/test/run`
- Volumes are recursively asked to verify for overlaps for points generated on the surface against their respective mother and volumes at the same level, performing for daughters and daughters of daughters etc.
 - It may take a very long time in complex geometries
 - Parameters which can be tuned:
 - `recursion_start` – starting depth level (default 0)
 - `recursion_depth` – the total depth level for checking overlaps (default -1, which mean all levels)
 - `tolerance` – tolerance by which overlaps should not be reported.
 - `resolution` - the number of points on surface to be generated and checked for each volume (default is '10000')
 - `maximum_errors` - the threshold for the number of errors to be reported for a single volume (default is 1)

Debugging Run-time Commands (2)

- Example of a test output

```
GeomTest: no daughter volume extending outside mother detected.
GeomTest Error: Overlapping daughter volumes
  The volumes Tracker[0] and Overlap[0],
  both daughters of volume World[0],
  appear to overlap at the following points in global coordinates: (list truncated)
length (cm)      ----- start position (cm) ----- ----- end position (cm) -----
  240             -240       -145.5       -145.5       0         -145.5       -145.5
Which in the mother coordinate system are:
length (cm)      ----- start position (cm) ----- ----- end position (cm) -----
  . . .
Which in the coordinate system of Tracker[0] are:
length (cm)      ----- start position (cm) ----- ----- end position (cm) -----
  . . .
Which in the coordinate system of Overlap[0] are:
length (cm)      ----- start position (cm) ----- ----- end position (cm) -----
```

Summary

- Several classes can be used to define a repeated placement: [G4PVReplica](#), [G4PVDisin](#) and [G4PVParameterisedVolume](#)
- The volumes can be grouped together in a [G4AssemblyVolume](#) object and the whole group can be placed as a single “virtual” volume
- The volume hierarchies can be reflected using [G4ReflectionFactory](#)
- Geant4 does not allow for malformed geometries, neither protruding nor overlapping
 - **Geometry checking tools are available to detect such cases**

Backup

Divisions

- Implemented as “special” kind of parameterised volumes:
 - [G4PVDivision](#) class derived from [G4PVParameterised](#)
 - But simpler to define as the parameterisation is calculated automatically using the values provided in input
- Similar to [G4PVReplica](#)
 - But it allows gaps in between mother and daughter volumes or between daughters (offset)
- Applies to CSG-like and some specific solids only:
 - Box, tubs, cons, para, trd, polycone, polyhedra

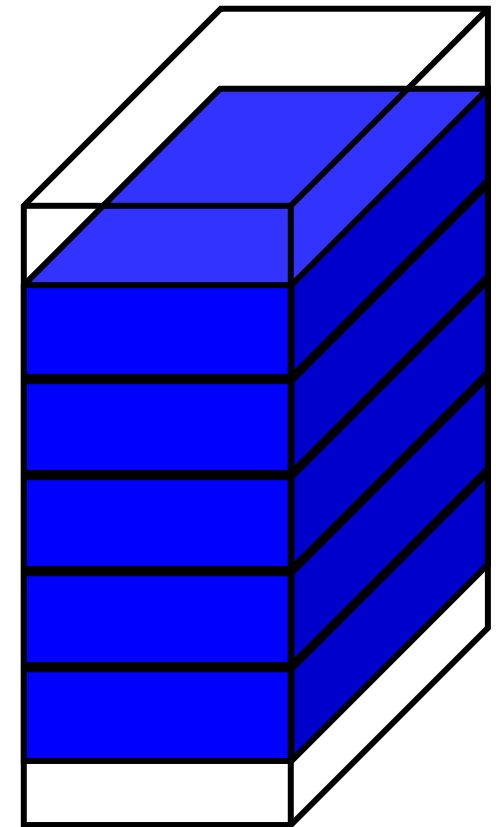

mother volume

G4PVDivision (1)

- Constructor 1:

```
G4PVDivision(  
  const G4String& name,           // physical volume name  
  G4LogicalVolume* currentLV,    // volume being replicated  
  G4LogicalVolume* motherLV,    // mother logical volume  
  const EAxis axis,              // axis of replication  
  const G4int nofDivisions,      // number of divisions  
  const G4double offset);       // division offset
```

- The size (width) of the daughter volume is calculated as
 $(\text{size of mother} - \text{offset}) / \text{nofDivisions}$

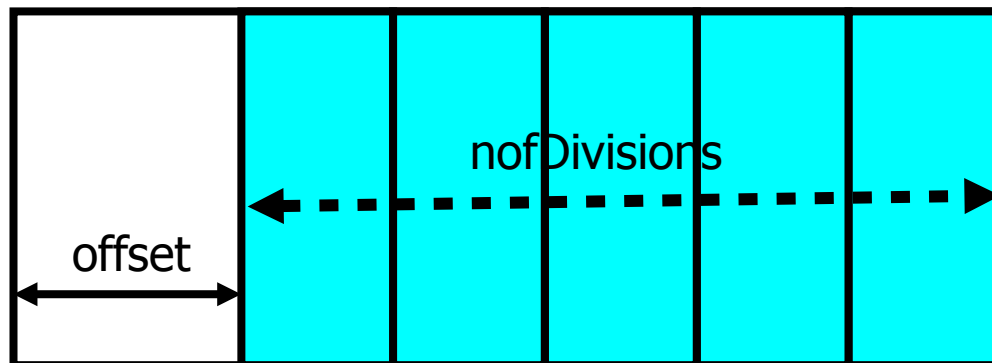

G4PVDivision (2)

- Constructor 2:

```
G4PVDivision(  
  const G4String& name,           // physical volume name  
  G4LogicalVolume* currentLV,    // volume being replicated  
  G4LogicalVolume* motherLV,     // mother logical volume  
  const EAxis axis,              // axis of replication  
  const G4double width,          // division width  
  const G4double offset);       // division offset
```

- The number of daughters volumes is calculated as
 $(\text{size of mother}) - \text{offset} / \text{nofDivisions}$

As many divisions as
width and offset allow



G4PVDivision (3)

- Constructor 3:

```
G4PVDivision(  
    const G4String& name,           // physical volume name  
    G4LogicalVolume* currentLV,     // volume being replicated  
    G4LogicalVolume* motherLV,     // mother logical volume  
    const EAxis axis,              // axis of replication  
    const G4int nofDivisions,       // number of divisions  
    const G4double width,          // division width  
    const G4double offset);        // division offset
```

- nofDivisions daughters of width thickness

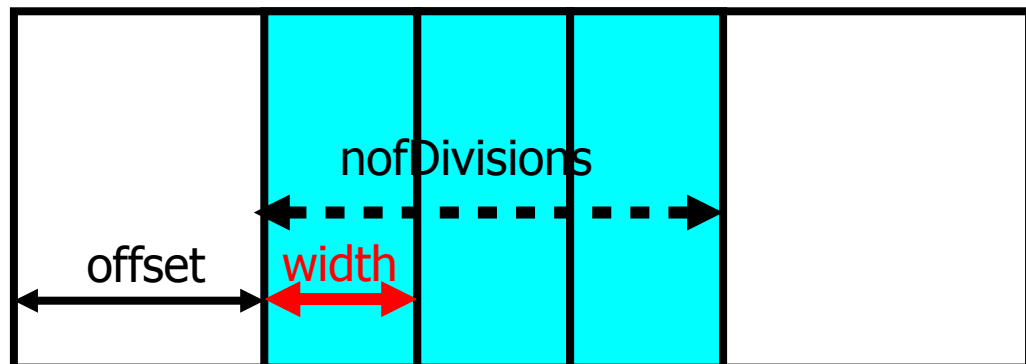

G4PVDivision (4)

- It is also possible to add `const G4double halfGap` parameter in addition to those in previous constructors

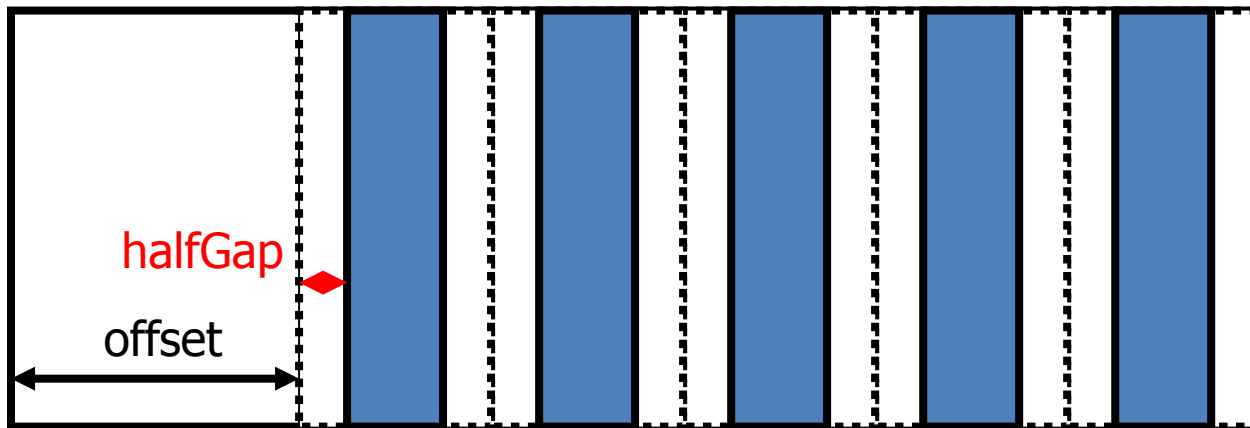

Parameterised Volumes

- Defined by [G4PVPParameterised](#)
 - More general than [G4PVReplica](#) and [G4PVDivisions](#)
 - The properties of the “replicas” in their mother volume are defined in a user parameterisation class derived from [G4VPVParameterisation](#)
- The properties which must be always provided:
 - Where it is positioned (transformation, rotation)
- Optional:
 - The size of the solid (dimensions)
 - The type of the solid, material, sensitivity, vis attributes
- The properties of the “replicas” are defined via their [copyNumber](#)

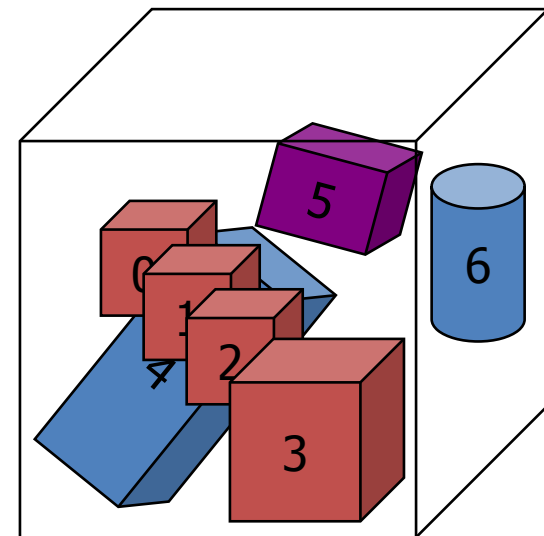

Example

- Basic example B2: the same geometry with simple placements (B2a) and parameterised volume (B2b)

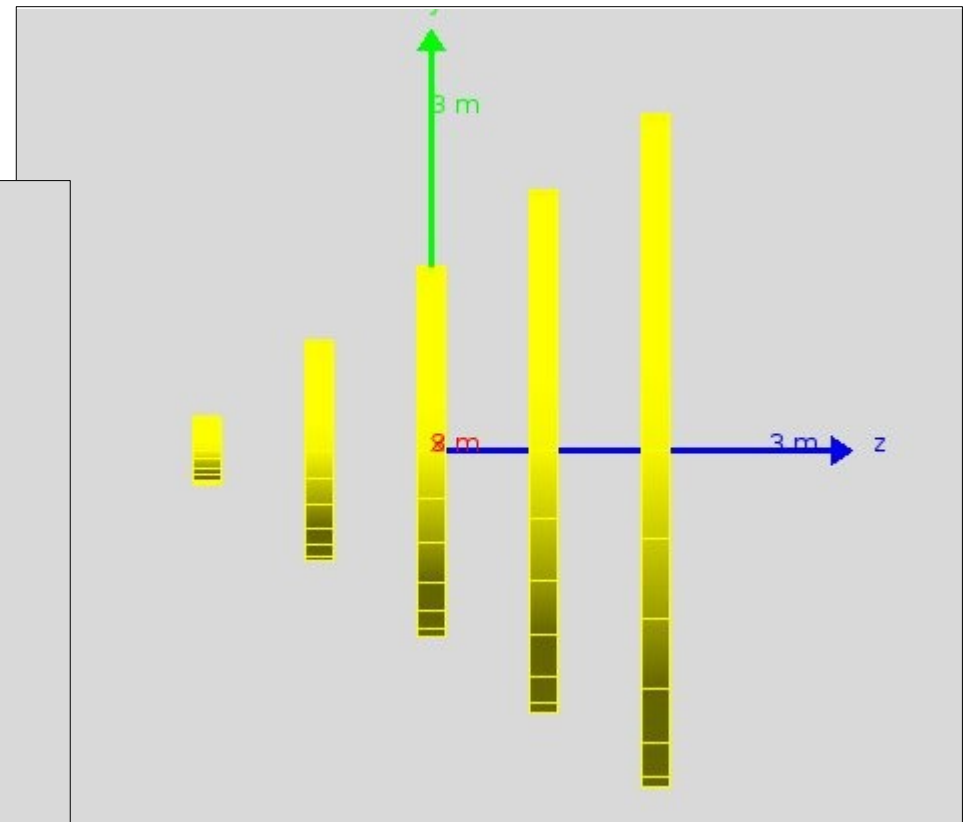
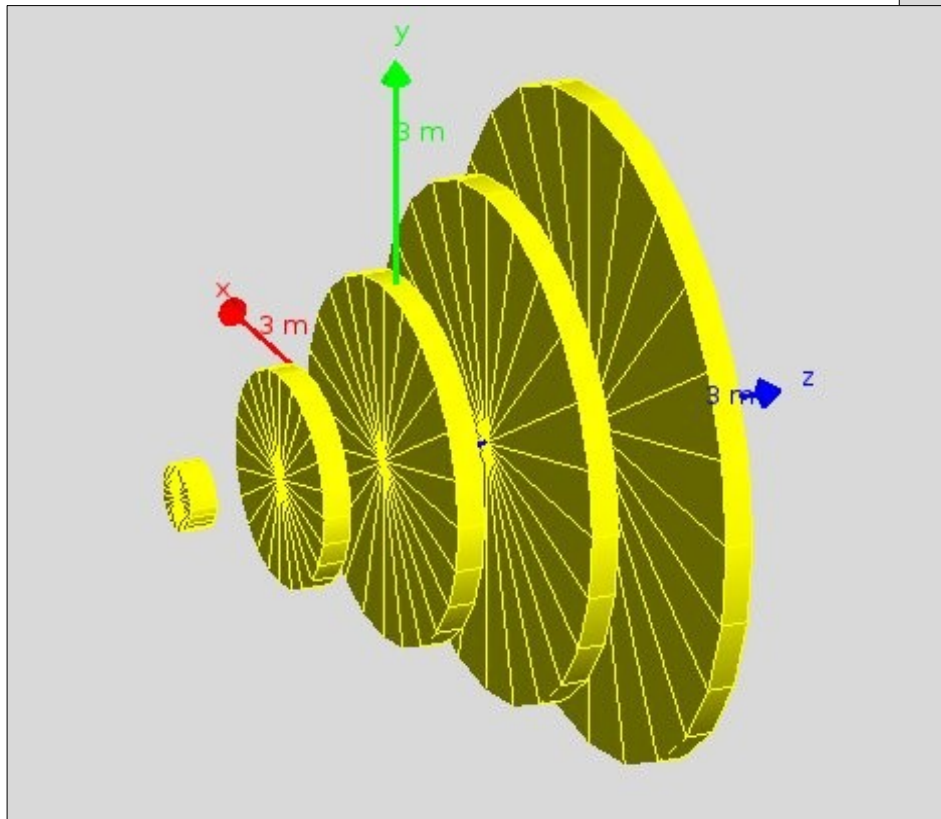

Six tracking chambers of increasing transverse size

G4PVPParameterised

- G4PVPParameterised constructor:

```
G4PVPParameterised(  
• const G4String& name,           // physical volume name  
• G4LogicalVolume* currentLV,    // volume being replicated  
• G4LogicalVolume* motherLV,    // mother logical volume  
• const EAxis axis,              // axis of replication  
• const G4int nofReplicas,       // number of replicas  
• G4VPVParameterisation* myParam); // parameterisation  
•
```

- Features and restrictions:
 - Replicates the volume nofReplicas times using the parameterisation myParam, within the mother volume
 - The positioning of the replicas is dominant along the specified Cartesian axis
 - If kUndefined is specified as axis, 3D voxelisation for optimisation of the geometry is adopted

MyParameterisation.hh

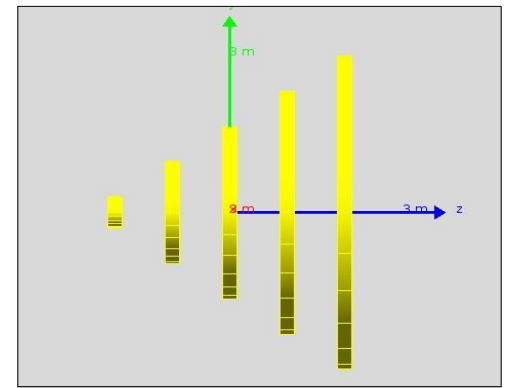

```
class B2bChamberParameterisation : public G4VPVParameterisation
{
public:
    B2bChamberParameterisation(..);
    virtual ~B2bChamberParameterisation();

    virtual void ComputeTransformation(
        const G4int copyNo,
        G4VPhysicalVolume* physVol) const;
    Virtual void ComputeDimensions (
        G4Tubs & trackerLayer, const G4int copyNo,
        const G4VPhysicalVolume* physVol) const;
private:
    // Dummy declarations to get rid of warnings ...
    // Data members of the class (with self-descriptive names)
};
```

MyParameterisation.cc

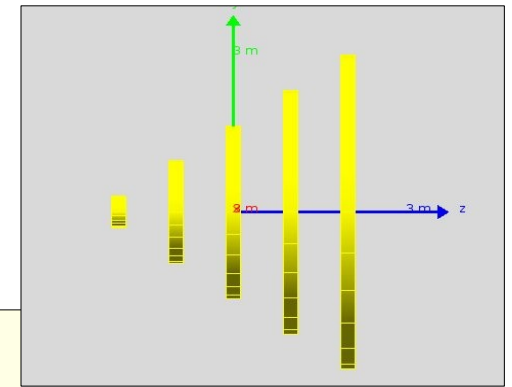

```
void B2bChamberParameterisation::ComputeTransformation(
    const G4int copyNo, G4VPhysicalVolume* physVol) const
{
    // Note: copyNo will start with zero!
    G4double zPosition = fStartZ + copyNo * fSpacing;
    G4ThreeVector origin(0, 0, zPosition);
    physVol->SetTranslation(origin);
    physVol->SetRotation(0);
}

void B2bChamberParameterisation::ComputeDimensions(
    G4Tubs& trackerChamber, const G4int copyNo,
    const G4VPhysicalVolume*) const
{
    // Note: copyNo will start with zero!
    G4double rmax = fRmaxFirst + copyNo * fRmaxIncr;
    trackerChamber.SetInnerRadius(0);
    trackerChamber.SetOuterRadius(rmax);
    trackerChamber.SetZHalfLength(fHalfWidth);
    trackerChamber.SetStartPhiAngle(0.*deg);
    trackerChamber.SetDeltaPhiAngle(360.*deg);
}
```

MyDetectorConstruction.cc

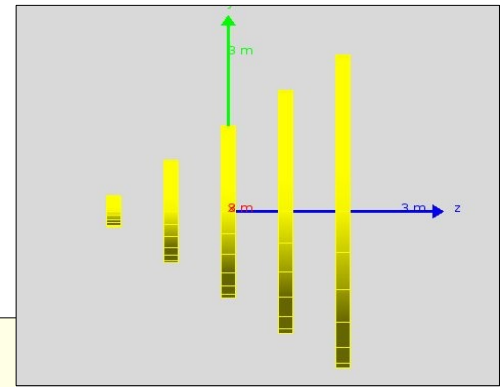

```
void B2bDetectorConstruction::Construct {
    ...
    G4Tubs* chamberS
        = new G4Tubs("tracker",0, 100*cm, 100*cm, 0.*deg, 360.*deg);
    fLogicChamber
        = new G4LogicalVolume(chamberS,fChamberMaterial,"Chamber",0,0,0);

    G4VPVParameterisation* chamberParam
        = new B2bChamberParameterisation(..);

    new G4PVPParameterised(
        "Chamber",           // their name
        fLogicChamber,      // their logical volume
        trackerLV,          // Mother logical volume
        kZAxis,              // Are placed along this axis
        NbOfChambers,       // Number of chambers
        chamberParam,       // The parametrisation
        fCheckOverlaps);    // checking overlaps
}
```

G4AssemblyVolume

```
G4AssemblyVolume::AddPlacedVolume(  
    G4LogicalVolume* volume,  
    G4ThreeVector& translation,  
    G4RotationMatrix* rotation );
```

- Helper class to combine daughter logical volumes in arbitrary way
 - Imprints of the assembly volume are made inside a mother logical volume through `G4AssemblyVolume::MakeImprint(...)`
- Each physical volume name is generated automatically
 - Format: `av_WWW_impr_XXX_YYY_ZZZ`
 - `WWW` – assembly volume instance number
 - `XXX` – assembly volume imprint number
 - `YYY` – name of the placed logical volume in the assembly
 - `ZZZ` – index of the associated logical volume
- Generated physical volumes (and related transformations) are automatically managed (creation and destruction)

Reflecting volumes

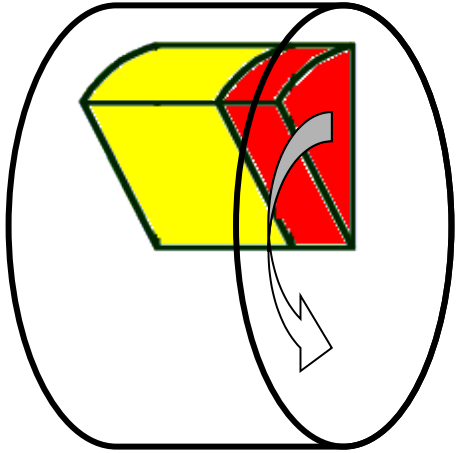

- Let's take an example of a pair of mirror symmetric volumes.
- Such geometry cannot be made by parallel transformation or 180 degree rotation.

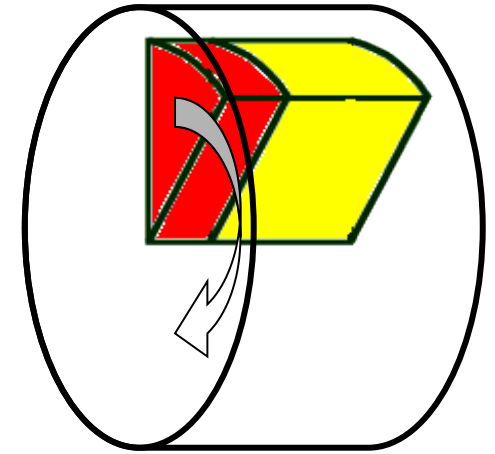

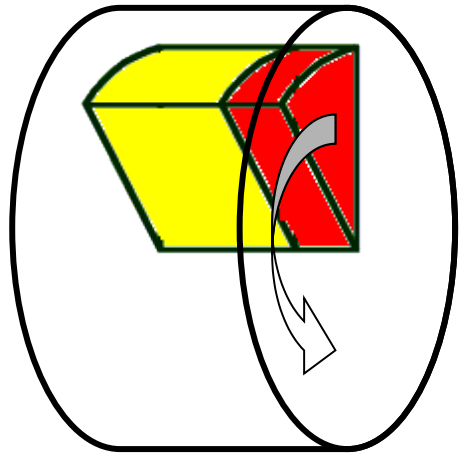

Reflecting volumes

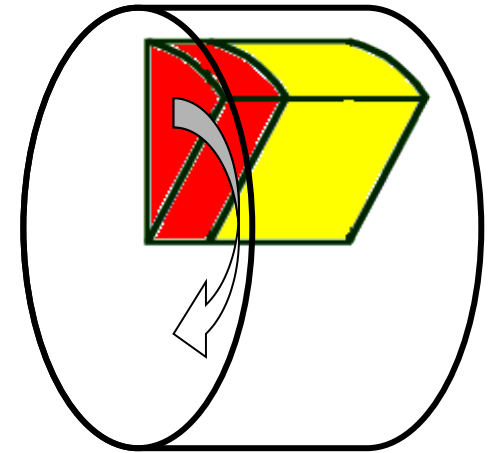

- Hierarchies of volumes based on CSG or specific solids can be reflected by means of [G4ReflectionFactory](#)
 - Singleton object using [G4ReflectedSolid](#) for generating placements of reflected volumes
 - The functions [Place\(..\)](#) or [Replicate\(..\)](#) should be used instead of [G4PVPlacement](#) or [G4PVReplica](#) when placing or replicating a volume in a volume hierarchy containing reflections
 - See more details in backup slides
- [G4ReflectedSolid](#)
 - Utility class representing a solid shifted from its original reference frame to a new symmetric one
 - The reflection ([G4Reflect\[X/Y/Z\]3D](#)) is applied directly to a solid, and a reflected solid is placed with “pure” rotation and translation
 - Reflections can be applied to CSG and specific solids

Reflecting hierarchies of volumes - 1

```
G4PhysicalVolumesPair G4ReflectionFactory::Place(  
  const G4Transform3D& transform3D, // the transformation  
  const G4String& name,           // the name  
  G4LogicalVolume* currentLV,     // the logical volume  
  G4LogicalVolume* motherLV,     // the mother volume  
  G4bool noBool,                 // currently unused  
  G4int copyNo);                 // optional copy number
```

- Used for normal placements:
 - 1) Performs the transformation decomposition
 - 2) Generates a new reflected solid and logical volume.
 - Retrieves it from a map if the reflected object is already created.
 - 3) Transforms any daughter and places them in the given mother
 - 4) Returns a pair of physical volumes, the second being a placement in the reflected mother
- `G4PhysicalVolumesPair` is
 - `std::map<G4VPhysicalVolume*, G4VPhysicalVolume*>`

Reflecting hierarchies of volumes - 2

```
G4PhysicalVolumesPair G4ReflectionFactory::Replicate(  
    const G4String& name,           // the name  
    G4LogicalVolume* currentLV,     // the logical volume  
    G4LogicalVolume* motherLV,     // the mother volume  
    Eaxis axis,                     // axis of replication  
    G4int nofReplica,               // number of replicas  
    G4double width,                // width of single replica  
    G4int offset = 0);             // offset (optional)
```

- Creates replicas in the given mother volume
- Returns a pair of physical volumes, the second being a replica in the reflected mother